

# PALATINA

---

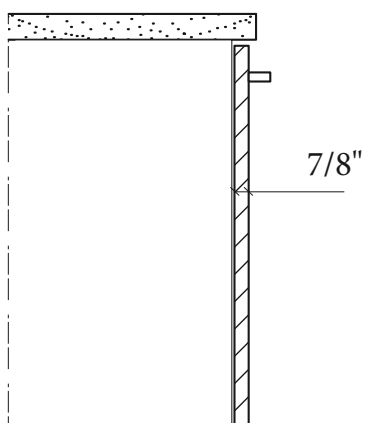

**Handle**  
maniglia  
tirador  
poignée  
Griff

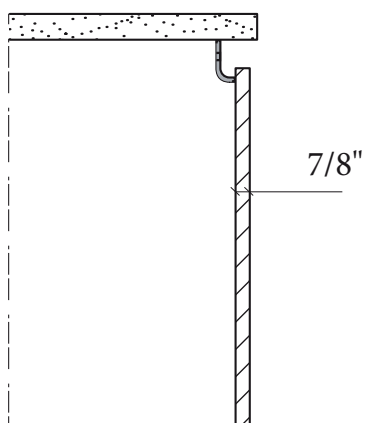

**Classic groove**  
gola classica  
gola clásica  
gorge classique  
klassische Griffleiste

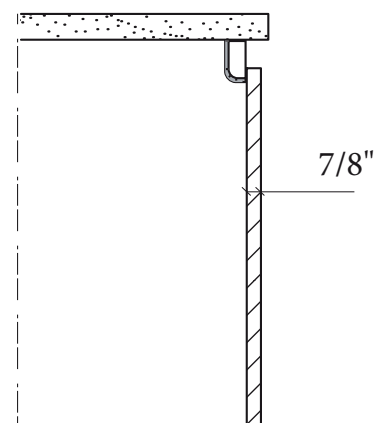

**Flat groove**  
gola piatta  
gola plana  
gorge plate  
flache Griffleiste

# PALATINA

## Matt silk lacquered MDF

MDF laccato opaco seta - MDF lacado seda mate  
MDF laqué mat soie - MDF Seidenmatt lackiert

 <b>9016</b> bianco traffico	 <b>200</b> bianco ghiaccio	 <b>201</b> bianco soft	 <b>9001</b> crema	 <b>202</b> yuta
 <b>203</b> grigio corda	 <b>204</b> beige avena	 <b>205</b> grigio fossile	 <b>206</b> ecrù	 <b>207</b> noisette
 <b>208</b> canapa	 <b>209</b> marrone	 <b>210</b> verde oliva	 <b>211</b> mandarino	 <b>212</b> rosso
 <b>213</b> bordeaux	 <b>214</b> amaranto	 <b>215</b> grigio light	 <b>216</b> grigio soft	 <b>217</b> blu notte
 <b>218</b> grigio hot	 <b>219</b> grigio fumo	 <b>220</b> ardesia	 <b>221</b> grigio stone	 <b>9005</b> nero profondo

## Gloss lacquered MDF

MDF laccato lucido - MDF lacado brillo  
MDF laqué brillant - MDF hochglanz lackiert

 <b>9016</b> bianco traffico	 <b>200</b> bianco ghiaccio	 <b>201</b> bianco soft	 <b>9001</b> crema	 <b>202</b> yuta
 <b>203</b> grigio corda	 <b>204</b> beige avena	 <b>205</b> grigio fossile	 <b>206</b> ecrù	 <b>207</b> noisette
 <b>208</b> canapa	 <b>209</b> marrone	 <b>210</b> verde oliva	 <b>211</b> mandarino	 <b>212</b> rosso
 <b>213</b> bordeaux	 <b>214</b> amaranto	 <b>215</b> grigio light	 <b>216</b> grigio soft	 <b>217</b> blu notte
 <b>218</b> grigio hot	 <b>219</b> grigio fumo	 <b>220</b> ardesia	 <b>221</b> grigio stone	 <b>9005</b> nero profondo

# PALATINA

---

## Flame-finish oak veneered

IMPIALLACCIATO rovere fiammato - contachapado roble acabado flameado plaqué chêne fin. flammé - Eiche-geflammt furniert



401 rovere naturale

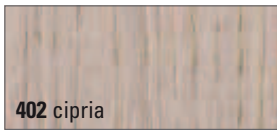

402 cipria

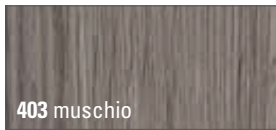

403 muschio



404 grigio siliceo

## Knotted-finish oak veneered

IMPIALLACCIATO rovere nodato - contachapado roble con nudos plaqué chêne avec noeuds - Eiche mit Knotten furniert

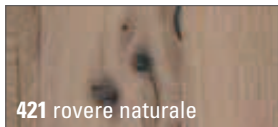

421 rovere naturale

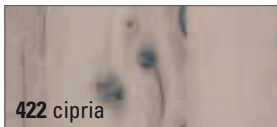

422 cipria

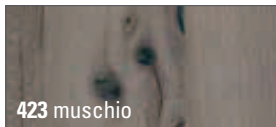

423 muschio



424 grigio siliceo

## Lacquered MDF with oxidized metal effect, mat lacquered back in the same color

MDF laccato effetto metallo ossidato, retro laccato opaco in tinta - MDF lacado efecto metal oxidado, interior lacado mate en el mismo color MDF laqué effet métal oxidé, dos laqué mat dans le même ton - MDF lackiert Oberfläche oxidiertes Metall-Effekt, Rücken lackiert in der selben Farbe

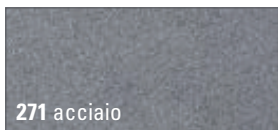

271 acciaio

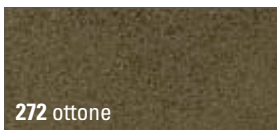

272 ottone

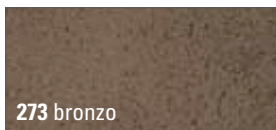

273 bronzo

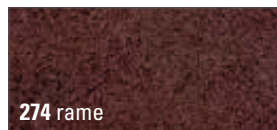

274 rame

## Cement Resin

resina cemento - resina cemento  
résine ciment - Harz Zement

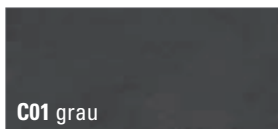

C01 grau

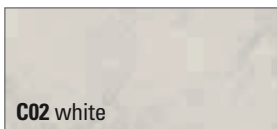

C02 white

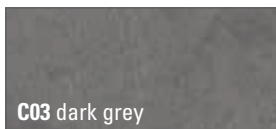

C03 dark grey

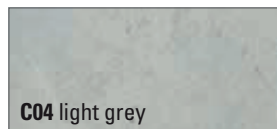

C04 light grey

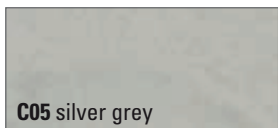

C05 silver grey

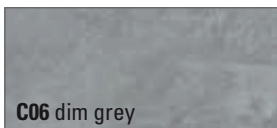

C06 dim grey

## Cooked oak veneered

IMPIALLACCIATO rovere termocotto - contachapado roble cocido plaqué chêne cuit - Eiche gekocht furniert

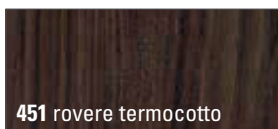

451 rovere termocotto

# PALATINA

---

## CEMENT RESIN "OSSIDI"

RESINA CEMENTO OSSIDI - resina cemento  
"OSSIDI" résine ciment "OSSIDI" - Harz Zement "OSSIDI"

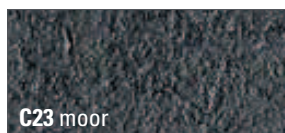
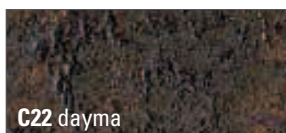
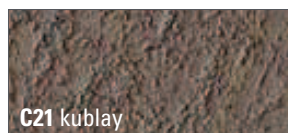

---

## "OLD" oak

ROVERE OLD - roble "OLD"  
chêne "OLD" - Eiche "OLD"

